

# M52300BSP

## NTSC VIDEO CHROMA DEFLECTION PROCESSOR

### DESCRIPTION

M52300BSP semiconductor integrated circuit has a built-in I<sup>2</sup>C interface, and processes video signals and color signals. It also has all necessary functions to process horizontal and vertical signals, except the vertical signal ramp voltage generation circuit.

This IC can be used in all kinds of television sets, including reasonably priced ones and high-grade ones. It also helps simplify TV set production lines, thanks to the I<sup>2</sup>C-bus control.

### FEATURES

- With the built-in I<sup>2</sup>C interface, this IC requires fewer peripheral components than conventional ones, helping simplify production lines.
- Black signal expanding circuit ensures dynamic image reproduction.
- Built-in flesh color compensation circuit ensures improved color reproduction.
- Sharp images are reproduced thanks to the contour compensation system with a built-in delay line.
- Provided with IQ demodulation, this IC reproduces color difference signals precisely. It can be connected to external RGB input easily because an on-screen character display circuit is built in, reducing external components such as switch circuits.
- Horizontal and vertical signals are counted down by the 32f H generator, therefore no adjustment is necessary.

### APPLICATION

NTSC color televisions

### RECOMMENDED OPERATING CONDITION

Supply voltage range.....	4.5~5.5V (pin 38)
	8.5-9.5V (pins 24 and 46)
Rated supply voltage.....	5.0V (pin 38)
	9.0V (pins 24 and 46)
Supply current range.....	11.0~21.0mA (pin 41)
Reted supply current.....	16.0mA (pin 41)

### PIN CONFIGURATION (TOP VIEW)

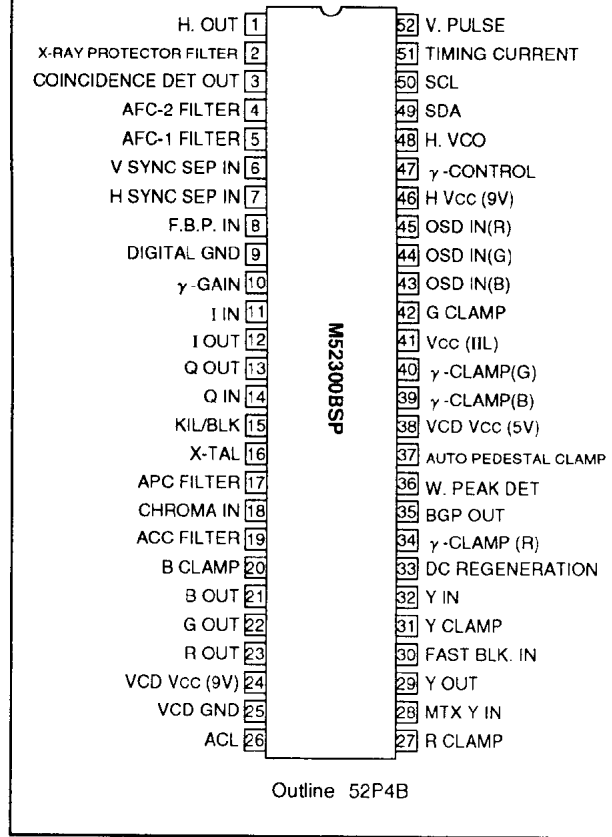

NTSC VIDEO CHROMA DEFLECTION PROCESSOR

BLOCK DIAGRAM

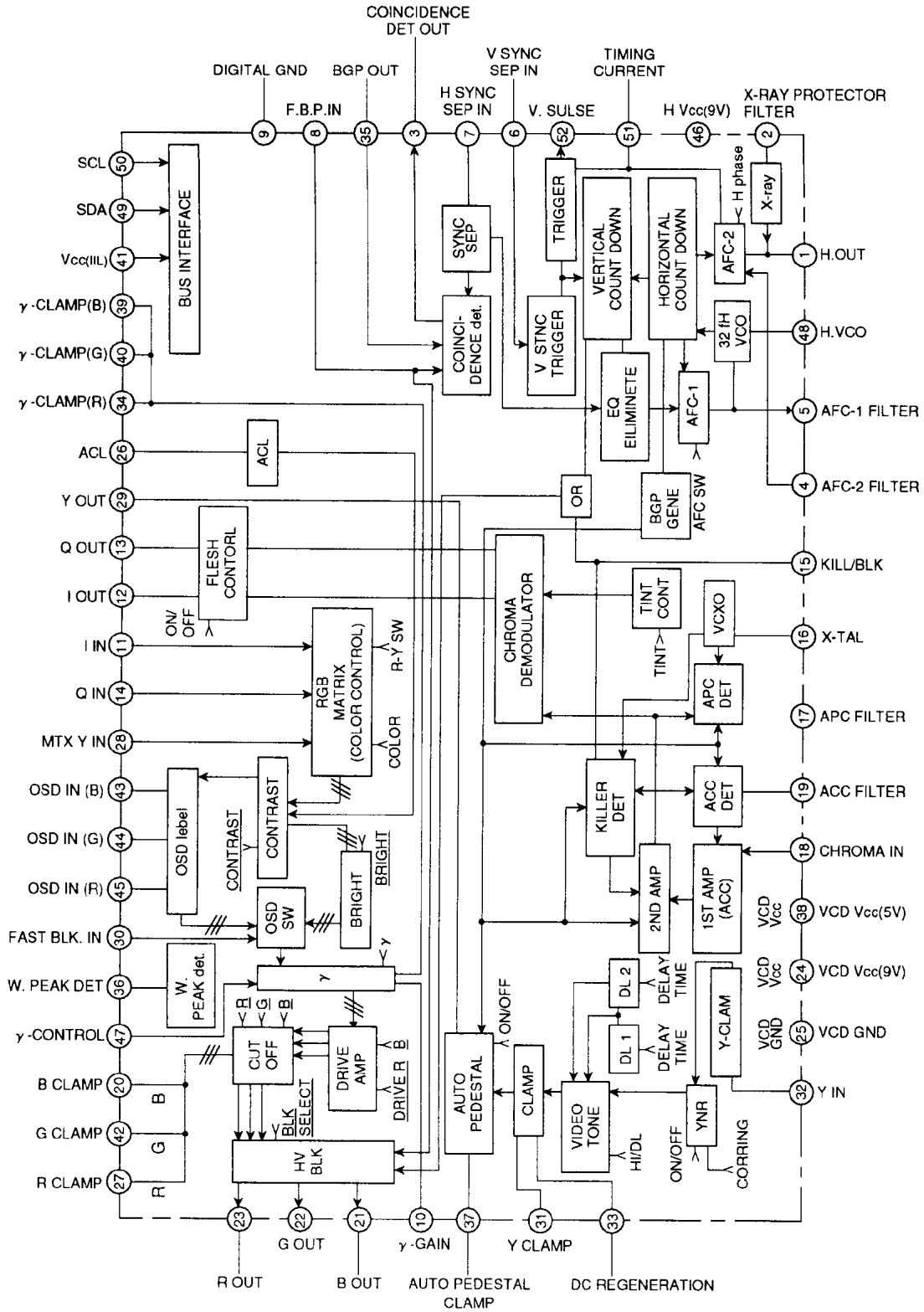















NTSC VIDEO CHROMA DEFLECTION PROCESSOR

ELECTRICAL CHARACTERISTICS (cont.)

Symbol	Parameter	Sub address	02H		03H	04H	05H	07H	08H	0AH		0BH	0CH	0DH	0EH	0FH	10H	11H				12H				
		Function	D1	D2	SH	CONC	COR	COL	TIM	HP	γ	BR1	D(R)	C(G)	C(R)	C(G)	C(B)	B(R)	B(G)	B(B)	FLE	DEM	SER	AF1	AUT	YNR
CCN1	Contrast control characteristic 1	Sub address																								
		Function				0																				
CCN4	Contrast control characteristic 4	Sub address																								
		Function				64																				
CCN7	Contrast control characteristic 7	Sub address																								
		Function				126																				
CCN10	Contrast control characteristic 10	Sub address																								
		Function				OFF																				
BR1	Brightness control characteristic 1	Sub address																								
		Function																								
BR4	Brightness control characteristic 4	Sub address																								
		Function										0														
BR7	Brightness control characteristic 7	Sub address																								
		Function											127													
OSD4	OSD level 4	Sub address																								
		Function																								
OSD8	OSD level 8	Sub address																								
		Function																								
OSD12	OSD level 12	Sub address																								
		Function																								
ACL	ACL	Sub address																								
		Function					0																			
DAG1	Drive amplifier gain 1	Sub address																								
		Function											0	0												
DAG2	Drive amplifier gain 2	Sub address																								
		Function											0	0												
DAG3	Drive amplifier gain 3	Sub address																								
		Function											0	0												
DAG4	Drive amplifier gain 4	Sub address																								
		Function											63	63												
DAG5	Drive amplifier gain 5	Sub address																								
		Function											63	63												
DAG6	Drive amplifier gain 6	Sub address																								
		Function											63	63												
CUT1	Cutoff 1	Sub address																								
		Function												64	64	64										
CUT4	Cutoff 4	Sub address																								
		Function												0	0	0										
CUT7	Cutoff 7	Sub address																								
		Function												127	127	127										
RGB BW1	RGB frequency characteristic 1	Sub address																								
		Function																				OFF	OFF	OFF	ON	ON
OSD S1	OSD speed 1	Sub address																								
		Function																								
FAST S1	FAST BLK speed 1	Sub address																								
		Function																								
WP	White peak det. 1	Sub address																								
		Function																								

NTSC VIDEO CHROMA DEFLECTION PROCESSOR

ELECTRICAL CHARACTERISTICS (cont.)

Symbol	Parameter	Sub address	02H		03H	04H	05H	07H	08H	0AH		0BH	0CH	0DH	0EH	0FH	10H	11H				12H				
			D1	D2	SH	CON	COR	COL	TIM	HP	γ	BR1	D(R)	C(G)	C(R)	C(G)	C(B)	B(R)	B(G)	B(B)	FLE	DEM	SER	AF1	AUT	YNR
BLKK W1	Blanking width 1	Sub address																								
		Function																								
—	Deflection system standard conditions	Sub address	0							4									115				11			
		Function	0	0		32	64	4	64	64	0	4	64	32	32	127	127	127	OFF	OFF	OFF	ON	100*	OFF	LO	OFF
FH	Horizontal signal oscillation frequency	Sub address																								
		Function																								
V46 MINF	Horizontal signal oscillation starting voltage	Sub address																								
		Function																								
FPH1	Horizontal signal pull-in range 1	Sub address																								
		Function																								
FPH2	Horizontal signal pull-in range 2	Sub address																								
		Function																								
TH	Horizontal signal pulse width	Sub address																								
		Function																								
VH	Horizontal signal output voltage	Sub address																								
		Function																								
FV	Vertical signal oscillation frequency	Sub address																								
		Function																								
TV	Vertical signal pulse width	Sub address																								
		Function																								
FPV	Vertical signal pull-in range	Sub address																								
		Function																								
TGP	Burst gate pulse position	Sub address																								
		Function																								
TBP1	Burst gate timing 1	Sub address																								
		Function																								
TB GP2	Burst gate timing 2	Sub address																								
		Function																								
FBP	FBP IN TH voltage	Sub address																								
		Function																						ON	LO	ON
VOH	Vertical signal output HI voltage	Sub address																								
		Function																								
VOL	Vertical signal output LO voltage	Sub address																								
		Function																								
HISS	Horizontal signal sync separation input circuit current	Sub address																								
		Function																								
VISS	Vertical signal sync separation input circuit current	Sub address																								
		Function																								
X	X-ray protection voltage	Sub address																								
		Function																								
V3L	Coincidence detection LO voltage	Sub address																								
		Function																								
AFC	AFC gain	Sub address																								
		Function																						OFF	HI	ON
HP	Horizontal signal phase	Sub address								/120																
		Function								15	0															
VW	Minimum vertical signal sync detection width	Sub address																								
		Function																								

NTSC VIDEO CHROMA DEFLECTION PROCESSOR

ELECTRICAL CHARACTERISTICS (cont.)

Symbol	Parameter	Sub address	02H		03H	04H	05H	07H	08H	0AH	0BH	0CH	0DH	0EH	0FH	10H	11H			12H						
		Function	D1	D2	SH	CON	COR	COL	TIM	HP	$\gamma$	BR1	D(R)	C(G)	C(R)	C(G)	C(B)	B(R)	B(G)	B(B)	FLE	DEM	SER	AF1	AUT	YNR
VV	Minimum vertical signal sync input voltage	Sub address																								
		Function																								
SSI	Service SW 1	Sub address																								
		Function																						ON	LO	OFF
SS2	Service SW 2	Sub address																								
		Function																						ON	LO	OFF

ELECTRICAL CHARACTERISTICS TEST METHODS

YMAX 1

- Set signal a to 100kHz and 1.0V<sub>P-P</sub>, and input it via SG32.
- Measure pin 29 output amplitude(P-P), as shown below:



- Calculate BLST<sub>n</sub> as follows:  $BLST_n = V_B / V_w \times 100$  [IRE]

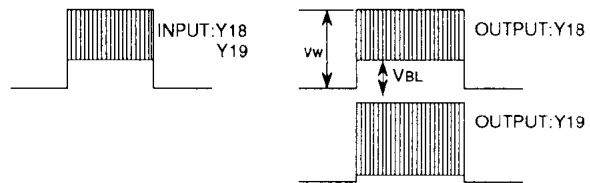

GY1

- Set signal a to 100kHz and 0.35V<sub>P-P</sub>, and input it via SG32.
- Measure pin 29 output amplitude(P-P). It is called G1.

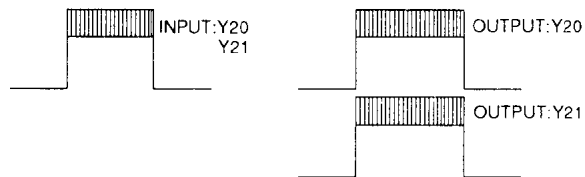

(3)  $GY1 = 20 \log(G1(V_{P-P}) / 0.35(V_{P-P}))$  [dB]

YTMAX

- Input signal a (f=3MHz) via SG32.
- Measure pin 29 output amplitude. It is called YT1.
- $YTMID1 = 20 \log(YT1 / \text{input amplitude})$  [dB]

YTMIN

- Input signal a (f=3MHz) via SG32.
- Measure pin 29 output amplitude. It is called YT2.
- $YTMID2 = 20 \log(YT2 / \text{input amplitude})$  [dB]

BLST3 and BLST4

- Set signal c to 100kHz,  $V_1 = 0.15V$  and  $V_2 = 0.2V$ , and input it via SG32.
- Input signal n via SG15.
- Measure pin 29 output amplitude (voltage from pedestal to "white" peak). It is called  $V_w$ . Measure setup voltage (voltage from pedestal and sine wave bottom.) It is called  $V_{BL}$ .

YBW

- Set signal a to 7 MHz and 0.35V<sub>P-P</sub>, and input it via SG32.
- Measure pin 29 output amplitude (sine-wave portion). It is called YB.
- $YBW = 20 \log[YB(V_{P-P}) / GY1(V_{P-P})]$  [dB]

DC REG1

- Set signal b to sync level 0, and input it via SG32.
- Measure DC voltage at where pin 29 output is lowest.

DC REG2

- Set signal b to sync level 0, and input it via SG32.
- Measure DC voltage at where pin 29 output is lowest. This voltage is called DCR2.
- $DCREG2 = DCREG1 - DCR2$

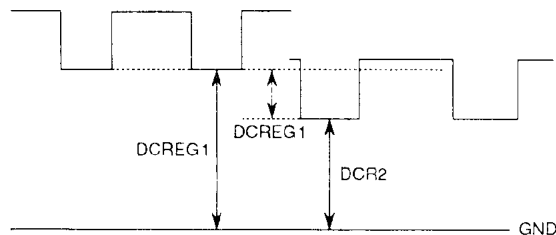

NTSC VIDEO CHROMA DEFLECTION PROCESSOR

**YLIN**

- (1) Set signal a to 100kHz and 0.7V<sub>P-P</sub>, and input it via SG32.
- (2) Measure pin ⑳ output amplitude(sine wave portion). It is called YL.
- (3)  $YLIN=20\log (1-YL/2G1)[dB]$

**NRC1**

- (1) Set signal a to 100kHz and 50mV<sub>P-P</sub>, and input it via SG32.
- (2) Measure pin ㉑ output amplitude. It is called NR1.
- (3)  $NRC1=20\log [NR1 (mV_{P-P})/50 (mV_{P-P})][dB]$

**ACC1**

- (1) Input signal e via SG18.
- (2) Measure pin ㉒ output amplitude.

**ACC2**

- (1) Set signal e to -20dB, and input it via SG18.
- (2) Measure pin ㉒ output amplitude. It is called AC2.
- (3)  $ACC2=20\log [AC2(mV_{P-P})/ACC1(mV_{P-P})][dB]$

**ACC3**

- (1) Set signal e to +6dB, and input it via SG18.
- (2) Measure pin ㉒ output amplitude. It is called AC3.
- (3)  $ACC3=20\log [AC3(mV_{P-P})/ACC1(mV_{P-P})][dB]$

**KIL1**

- (1) Set signal e to -20dB, and input it via SG18.
- (2) Measure pin ㉓ DC voltage.

**KIL2**

- (1) Set signal e to -51dB, and input it via SG18.
- (2) Measure pin ㉓ DC voltage.

**DKIL**

- (1) Set eb of signal e (burst portion) to  $-\infty$  dB, and input it via SG18.
- (2) Measure pin ㉒ output amplitude.

**T1**

- (1) Set eb of signal e (burst portion) to  $-\infty$  dB, and input it via SG18.
- (2) Obtain the angle based on pin ㉒ output waveform, in the same way as for TCEN. This angle is called IT1.
- (3)  $T1=IT1-A1$

**T2**

- (1) Set eb of signal e (burst portion) to  $-\infty$  dB, and input it via SG18.
- (2) Obtain the angle based on pin ㉒ output waveform, in the same way as for TCEN. This angle is called IT2.
- (3)  $T2=IT2-A1$

**TT**

- (1)  $TT=IT1-IT2$

**FL**

- (1) Input signal 0 via SG18.
- (2) Obtain the angle based on pin ㉒ output waveform, in the same way as for TCEN. This angle is called IF.
- (3)  $FL=AI-IF$

**AIQ**

- (1)  $AIQ=AI-AQ$

**RIQ**

- (1) Set signal h<sub>fsc</sub> to 3.679545MHz (100kHz higher than normal), and input it via SG18.
- (2) Measure pin ㉔ output amplitude. It is called RI.
- (3) Measure pin ㉕ output amplitude. It is called RQ.
- (4)  $RIQ=RI/RQ$

**MTX1 through MTX7**

- (1) Set signal a to 100kHz and 0.35V<sub>P-P</sub>, and input it SG12.
- (2) Measure output amplitude (sine-wave portion) under appropriate switch/data conditions. The amplitude is called MT<sub>n</sub> (n=1, 2, ... or 7).
- (3)  $MTX1 \text{ through } MTX7=20\log (MT_n(V_{P-P})/0.35(V_{P-P}))[dB]$

**CC1**

- (1) Set signal a to 100kHz and 0.35V<sub>P-P</sub>, and input it via SG12.
- (2) Measure pin ㉖ output amplitude (sine-wave portion). It is called V<sub>cc1</sub>.
- (3) Calculate CC1 as follows:  $CC1=20\log (V_{cc1}/input)[dB]$

**CC2**

- (1) Set signal a to 100kHz and 0.35V<sub>P-P</sub>, and input it via SG12.
- (2) Measure pin ㉗ output amplitude (sine-wave portion). It is called CR1.
- (3)  $CC2=20\log (CB1/CC1)[dB]$

**CC3**

- (1) Set signal a to 100kHz and 0.35V<sub>P-P</sub>, and input it via SG12.
- (2) Measure pin ㉘ output amplitude (sine-wave portion). It is called CR2.
- (3)  $CC3=20\log (CB2/CC1)[dB]$

**CC4**

- (1) Set signal a to 100kHz and 0.35V<sub>P-P</sub>, and input it via SG12.
- (2) Measure pin ㉙ output amplitude (sine-wave portion). It is called V<sub>cc4</sub>.
- (3)  $CC4=20\log (V_{cc4}/input)$

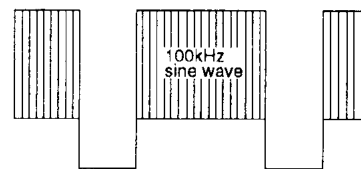

COMMON OUTPUT WAVEFORM

**CC5**

- (1) Set signal a to 100kHz and 0.35, and input it via SG12.
- (2) Measure pin ㉚ output amplitude (sine-wave portion). It is called CR3.
- (3)  $CC5=20\log (CR3/V_{cc4})[dB]$

**CC6**

- (1) Set signal a to 100kHz and 0.35V<sub>P-P</sub>, and input it via SG12.
- (2) Measure pin ㉛ output amplitude (sine-wave portion). It is called CR4.
- (3)  $CC6=20\log (CR4/V_{cc4})[dB]$

**CON1**

- (1) Set signal a to 100kHz and 0.5V<sub>P-P</sub>, and input it via SG28.
- (2) Measure pin ㉜, ㉝ and ㉞ output amplitudes (sine-wave portion).
- (3) Measure pin ㉞ voltage, It is called V<sub>con1</sub>.

## NTSC VIDEO CHROMA DEFLECTION PROCESSOR

**CON4**

- (1) Set signal a to 100kHz and 0.5V P-P, and input via SG28.
- (2) Measure pin ①, ② and ③ output amplitudes (sine-wave portion). The amplitudes are called, respectively, COB1, COG1 and COR1.
- (3)  $CON4B=20\log(COB1/CON1B)[dB]$
- (4)  $CON4G=20\log(COG1/CON1B)[dB]$
- (5)  $CON4R=20\log(COR1/CON1B)[dB]$

**CON7**

- (1) Set signal a to 100kHz and 0.5V P-P, and input it via SG28.
- (2) Measure pin ①, ② and ③ output amplitudes (sine-wave portion). The amplitudes are called, respectively, COB2, COG2 and COR2.
- (3)  $CON7B=20\log(COB2/CON1B)[dB]$
- (4)  $CON7G=20\log(COG2/CON1B)[dB]$
- (5)  $CON7R=20\log(COR2/CON1B)[dB]$
- (6) Measure pin ⑥. This is called VCON2.

**CON10**

- (1) Set signal a to 100kHz and 0.5V P-P, And input it via SG28.
- (2) Measure pin ①, ② and ③ output amplitudes (sine-wave portion). The amplitudes are called, respectively, COB3, COG3 and COR3.
- (3)  $CON10B=20\log(COB3/CON1B)[dB]$
- (4)  $CON10G=20\log(COG3/CON1B)[dB]$
- (5)  $CON10R=20\log(COR3/CON1B)[dB]$

**BR1 through BR9**

- (1) Input SG6 sync signal only.
- (2) Measure pin ①, ② and ③ output DC voltage, except at blanking portions.

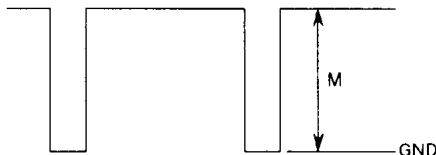
**OSD4 through DC12**

- (1) Input SG6 sync signal only.
- (2) Measure pin ①, ② and ③ output DC voltages, except at blanking portions.

**ACL**

- (1)  $ACL=V_{CON1}-V_{CON2}$  [mV]

**DAG1 and DAG4**

- (1) Set signal a to 100kHz and 0.5V P-P, and input it via SG28.
- (2) Measure pin ② output amplitudes (sine-wave portion) twice.

**Drive Amplifier Gains: DAG2, DAG3, DAG5 and DAG6**

- (1) Set signal a to 100 kHz and 0.5V P-P, and input it via SG28.
- (2) Measure pin ① (B OUT) and pin ③ (R OUT) output amplitudes (sine-wave portion). Repeat the measurement. The amplitudes are called DAGB1, DAGR1, DAGB2 and DAGR2.
- (3)  $DAG2=20\log(DAGB1/DAG1)[dB]$   
 $DAG3=20\log(DAGR1/DAG1)[dB]$   
 $DAG5=20\log(DAGB2/DAG4)[dB]$   
 $DAG6=20\log(DAGR2/DAG4)[dB]$

**CUT1 through CUT9**

- (1) Input SG6 sync signal only.
- (2) Measure pin ①, ② and ③ output DC voltage, except at blanking portions.

**RGB BW1 through BW3**

- (1) Set signal a to 4MHz and 0.5 V<sub>P-P</sub>, and input it via SG28.
- (2) Measure ①, ② and ③ output amplitudes (sine-wave portion). They are called, respectively, BWB, BWG and BWR.
- (3)  $RGB BW1=20\log(BWB/CON4)[dB]$   
 $RGB BW2=20\log(BWB/CON5)[dB]$   
 $RGB BW3=20\log(BWB/CON6)[dB]$

**OSD S1**

- (1) Set signal n to 5 V<sub>O-P</sub>, and input it via SG43.
- (2) Measure pin ①, ② and ③ output rise time and fall time, as shown below:

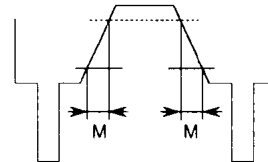
**FAST S1**

- (1) Set signal n to 5V<sub>O-P</sub>, and input it via SG30.
- (2) Measure pin ①, ② and ③ output rise time and fall time, in the same way as for I43.

**W and P**

- (1) Set signal a to 100kHz and 0.5V P-P, and input it via SG28.
- (2) Measure pin ⑥ output DC voltage.

**BLKW1 to BLKW3**

- (1) Measure pin ①, ② and ③ horizontal signal blanking width.

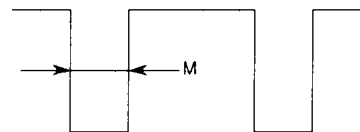
**FH**

- (1) Apply no input.
- (2) Measure pin ① output frequency.

**V46MIN**

- (1) Apply no input.
- (2) Set pin ④ voltage to 7.5V
- (3) Measure pin ① output frequency.

**FPH1**

- (1) Set signal k to 14.0kHz and input it via SG6. Check if pin ③ DC voltage is no more than 4.0V.
- (2) Increase signal k frequency gradually. Measure it when pin ③ DC voltage exceeds 5.0V. This frequency is called PL.
- (3)  $FPH1=PL-15.734$  [kHz]

NTSC VIDEO CHROMA DEFLECTION PROCESSOR

**FPH2**

- (1) Set signal k to 17.5kHz, and input it via SG6. Check if pin ③ DC voltage is no more than 4.0V.
- (2) Decrease signal k frequency gradually. Measure it when pin ③ DC voltage exceeds 5.0V. This frequency is called PH.
- (3)  $FPH2 = PH - 15.734$  [kHz]

**TH and VH**

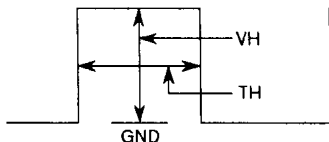

PIN ① OUTPUT WAVEFORM

**FV**

- (1) Apply no input.
- (2) Measure pin ⑤ frequency.

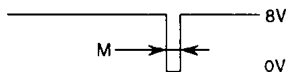

**FPV**

- (1) Set signal 1 to 100Hz. Input via SG6.
- (2) Monitoring pin ⑤ output frequency, lower signal 1 frequency.
- (3) Measure the frequency when pin ⑤ output frequency meets signal 1 frequency.

**TGP, TBGP1 and TBGP2**

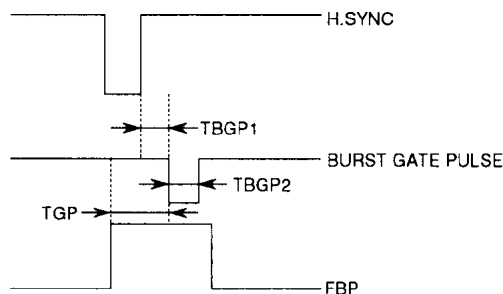

**FBP**

- (1) Pin ② output DC voltage.

**VOH, VOL and HISS**

- (1) Flow 1μA current out of pin ⑦, and increase the current.
- (2) Measure pin ① output frequency, and measure pin ⑦ outflow current when the frequency reaches a level that is below FH by 50Hz or more.

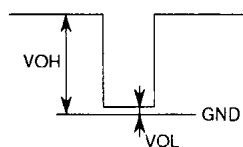

**VISS**

- (1) Flow 1μA current out of pin ⑥, and increase the current.
- (2) Measure pin ⑤ output frequency, and measure pin ⑥ outflow current when the frequency reaches a level that is above FV by 5Hz or more.

**X**

- (1) Apply 1.0V to pin ②.
- (2) Check if pin ① output is LO.

**V3L**

- (1) Apply no input.
- (2) Measure pin ③ DC voltage.

**AFC**

- (1) Measure pin ⑤ output amplitude difference when AFC SW setting is changed. (Sub-address 12 data is changed to C6 and C2.)

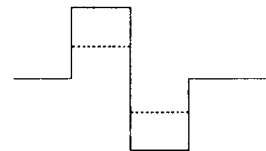

**HP**

- (1) Shift horizontal signal phase from the maximum to the minimum (by switching from A3 to B6 at sub-address 0A), and measure the change in the period between pin 1 pulse rise and sync fall.

**VW**



- (1) Input signal 1 to 20μsec 60Hz, and input it via SG6.
- (2) Measure pin ⑤ output frequency.

**VV**

- (1) Set signal 1 to 60Hz and 100mV P-P, and input it via SG6.
- (2) Measure pin ⑤ output frequency.

NTSC VIDEO CHROMA DEFLECTION PROCESSOR

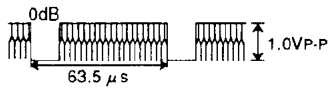
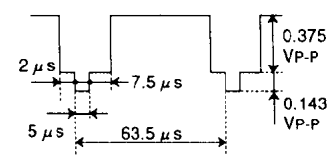
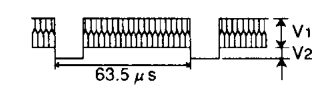
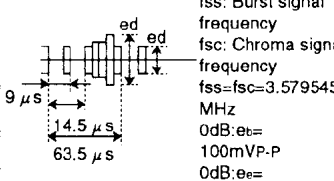
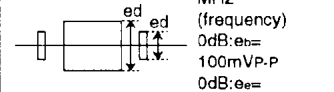
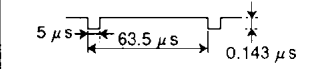
INPUT SIGNALS

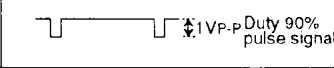
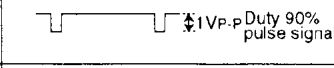
Symbol	Name	Description
a	Video signal (sine wave)	
b	APL 100% reference signal	
c	Video signal (sine wave)	
d	Sine wave	200mVP-P=0dB Frequency should be variable.
e	Chroma standard signal (color bar)	 <p>fss: Burst signal frequency fsc: Chroma signal frequency fss=fsc=3.579545 MHz 0dB:eb=100mVP-P 0dB:ee=200mVP-P</p>
f	Chroma signal-1	 <p>fss=fsc=3.579545 MHz (frequency) 0dB:ee=100mVP-P 0dB:ee=200mVP-P</p>
g	Chroma signal-2	Compared with chroma signal-1(f), both burst and chroma frequencies are variable with this signal.
h	Chroma signal-3	The same as chroma signal1-1 (f), except that fsc=5.529545MHz. (fss=3.579545MHz)
i	Standard reference signal	
j	APL 50% reference signal	
k	Periodic signal 1	
l	Periodic signal 2	
m	5MHz sine wave	0dB→100mVP-P

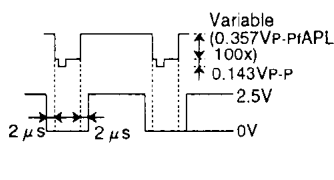
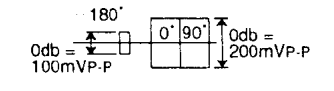
Symbol	Name	Description
n	Blanking pulse	
o	0° 90° chroma signal	

NTSC VIDEO CHROMA DEFLECTION PROCESSOR

TYPICAL CHARACTERISTICS

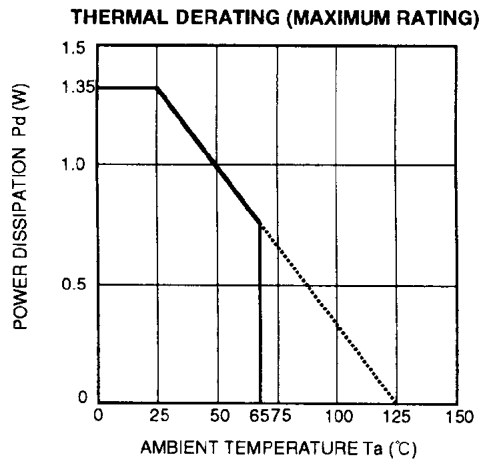



NTSC VIDEO CHROMA DEFLECTION PROCESSOR

APPLICATION EXAMPLE

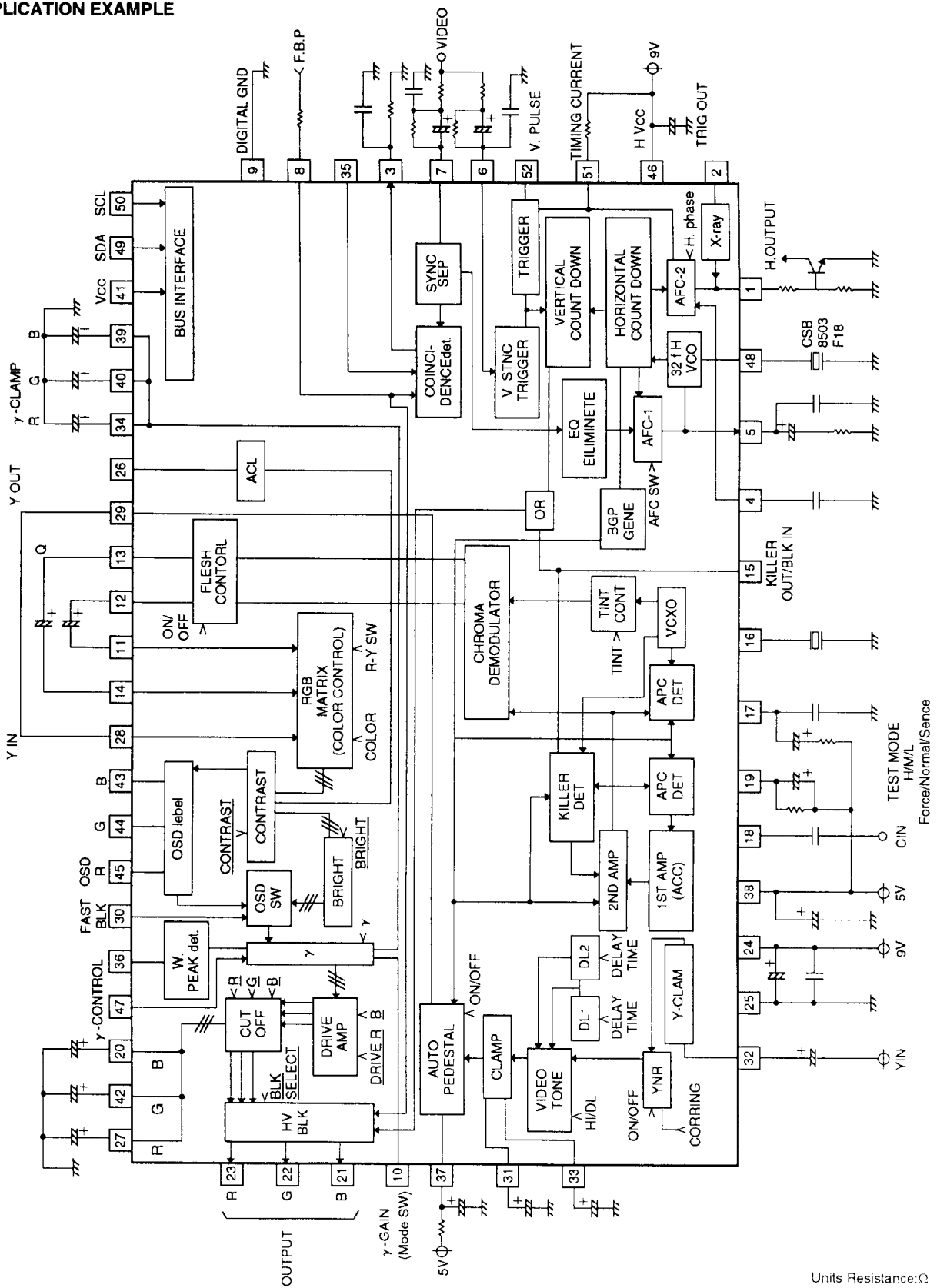

Units Resistance: Ω  
Capacitance: p

NTSC VIDEO CHROMA DEFLECTION PROCESSOR

DESCRIPTION OF PIN

Pin No.	Name	Voltage and wave information	Peripheral circuit of pins	DC voltage
①	H.OUT	—		—
②	X-RAY PROTECTOR FILTER	—		—
③	COINCIDENCE DET.OUT	—		—
④	AFC-2 FILTER	—		4.5V

NTSC VIDEO CHROMA DEFLECTION PROCESSOR

DESCRIPTION OF PIN (cont.)

Pin No.	Name	Voltage and wave information	Peripheral circuit of pins	DC voltage
⑤	AFC-1 FILTER	—		6.3V
⑥	V.SYNC SEP.IN	—		6.8V
⑦	H.SYNC SEP.IN	—		6.5V
⑧	FBP IN	—		—

NTSC VIDEO CHROMA DEFLECTION PROCESSOR

DESCRIPTION OF PIN (cont.)

Pin No.	Name	Voltage and wave information	Peripheral circuit of pins	DC voltage
⑨	DIGITAL GND	—	—	—
⑩	γ-GAIN	—		3.0V
⑪ ⑭	I IN Q IN	—		3.0V
⑫	I OUT	—		2.5V
⑬	Q OUT	—		2.5V

**NTSC VIDEO CHROMA DEFLECTION PROCESSOR**

**DESCRIPTION OF PIN (cont.)**

Pin No.	Name	Voltage and wave information	Peripheral circuit of pins	DC voltage
⑮	KILL/BLK	—		2.5V
⑯	X-TAL	3.58MHz of X-TAL		3.0V
⑰	APC FILTER	—		3.0V
⑱	CHROMA IN	—		—

NTSC VIDEO CHROMA DEFLECTION PROCESSOR

DESCRIPTION OF PIN (cont.)

Pin No.	Name	Voltage and wave information	Peripheral circuit of pins	DC voltage
①9	ACC FILTER	—		3.6V
②0 ②7 ④2	B CLAMP R CLAMP G CLAMP	—		3.5V
②1 ②2 ②3	B OUT G OUT R OUT	—		2.75V
②4	VCD Vcc (9V)	—	—	—
②5	VCD GND	—	—	—
②6	ACL	—		3.0V

**NTSC VIDEO CHROMA DEFLECTION PROCESSOR**

**DESCRIPTION OF PIN (cont.)**

Pin No.	Name	Voltage and wave information	Peripheral circuit of pins	DC voltage
②⑨	MTX Y IN	—		—
②⑧	Y OUT	—		3.0V
③①	FAST BLK. IN	—		5.3V
③①	Y CLAMP	—		—

NTSC VIDEO CHROMA DEFLECTION PROCESSOR

DESCRIPTION OF PIN (cont.)

Pin No.	Name	Voltage and wave information	Peripheral circuit of pins	DC voltage
32	Y IN	—		2.5V
33	DC REGENERATION	—		2.5V
34 39 40	γ-CLAMP (R) γ-CLAMP (B) γ-CLAMP (G)	—		3.5V
35	BGP OUT	—		3.7V



NTSC VIDEO CHROMA DEFLECTION PROCESSOR

DESCRIPTION OF PIN (cont.)

Pin No.	Name	Voltage and wave information	Peripheral circuit of pins	DC voltage
③⑥	W.PEAK DET.	—		6.8V
③⑦	AUTO PEDESTAL CLAMP	—		2.9V
③⑧	VCD Vcc 5V	—	—	—
④①	IIL GND	—	—	—
④③ ④④ ④⑤	OSD IN (B) OSD IN (G) OSD IN (R)	—		—
④⑥	H Vcc (9V)	—	—	—
④⑦	γ-CONTROL	—		—

NTSC VIDEO CHROMA DEFLECTION PROCESSOR

DESCRIPTION OF PIN (cont.)

Pin No.	Name	Voltage and wave information	Peripheral circuit of pins	DC voltage
48	H VCO	f=Approx. 500kHz		—
49	SDA	—		4.4V
50	SCL	—		4.4V
51	TIMING CURRENT	—		—

**NTSC VIDEO CHROMA DEFLECTION PROCESSOR**

**DESCRIPTION OF PIN (cont.)**

Pin No.	Name	Voltage and wave information	Peripheral circuit of pins	DC voltage
52	V PULSE	—		8.0V

**I<sup>2</sup>C-BUS ADDRESS LIST**

(1) Slave address

A6 A5 A4 A3 A2 A1 A0 R/W  
 1 0 1 1 1 0 1 0 (=BAH)

(2) Data format

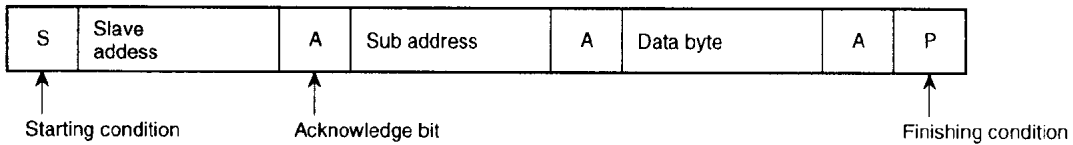

## NTSC VIDEO CHROMA DEFLECTION PROCESSOR

FUNCTIONS AND SUB ADDRESSED CONTROLLED BY I<sup>2</sup>C-BUS SYSTEM

No.	Parameter	Sub address	DC voltage							
			D7	D6	D5	D4	D3	D2	D1	D0
1	DL aperture cont. 1	02H	0	0	A25	A24	—	—	0	0
2	DL aperture cont. 2	02H	0	0	—	—	A23	A22	0	0
3	sharpness	03H	0	0	A35	A34	A33	A32	A31	A30
4	contrast cont	04H	0	A46	A45	A44	A43	A42	A41	A40
5	NR corring level	05H	0	0	0	0	0	A52	A51	A50
6	color cont	07H	0	A76	A75	A74	A73	A72	A71	A70
7	tint cont	08H	0	A86	A85	A84	A83	A82	A81	A80
8	AFC-2 H phase	0AH	0	AA6	AA5	AA4	AA3	—	—	—
9	r-position	0AH	0	—	—	—	—	AA2	AA1	AA0
10	bright cont	0BH	0	AB6	AB5	AB4	AB3	AB2	AB1	AB0
11	drive (R)	0CH	0	0	AC5	AC4	AC3	AC2	AC1	AC0
12	drive (B)	0DH	0	0	AD5	AD4	AD3	AD2	AD1	AD0
13	cut off (R)	0EH	0	AE6	AE5	AE4	AE3	AE2	AE1	AE0
14	cut off (G)	0FH	0	AF6	AF5	AF4	AF3	AF2	AF1	AF0
15	cut off (B)	10H	0	A106	A105	A104	A103	A102	A101	A100
16	BLK select (R)	11H		B-s(R)						
17	BLK select (G)	11H			B-s(G)					
18	BLK select (B)	11H				B-s(B)				
19	fresh cont on/off	11H							fresh cont	
20	demod axis	11H								demo
21	Service SW	12H					Service SW			
22	AFC-1 speed	12H						AFC-1		
23	auto pedestal on/off	12H							auto ped	
24	YNR on/off	12H								YNR